

One Year Unconditional Warranty

If for any reason, this ProMaster product fails within ONE YEAR of the date of purchase, return this product to your ProMaster dealer and it will be exchanged for you at no charge. ProMaster products are guaranteed for ONE FULL YEAR against defects in workmanship and materials. If at any time after one year, your ProMaster product fails under normal use, we invite you to return it to ProMaster for evaluation.

WWW.PROMASTER.COM | FAIRFIELD CT 06825

**FOR
CANON**

Made in China
Code 8574



200ST-R [*Canon*
Speedlight]

TTL Speedlight for Canon

200ST-R SPEEDLIGHT FOR CANON



Contents

Precautions	2
Foreword	3
Protection Film	5
Parts Identification	6
LCD Screen Icons	8
Inserting the Batteries	9
Attaching and Detaching	10
Turning On the Power	11
Home Screen and Key Lock	12
Setting Custom and Personal functions	13
Utility Menu: Custom Functions	14
Utility Menu: Personal Functions	15
TTL: E-TTL II Mode	16
M: Manual Mode	17
Repeating Flash Mode	18
Slave Mode F1 (Optical)	19
Slave Mode F2 (Optical)	20
2.4 GHz Slave Mode (Radio)	21
FEB	22
FEL: FE Lock	23
High-speed Sync	24
Second-curtain Sync	25
Power Zoom Function	26
AF Assist Beam Emitter	27
Bounce Flash Operation	28
Using the Bounce Card	29
Using the Wide Panel	30
Diffusion Dome	31
Color Filters	32
Additional Interfaces	33
Appendix	34
Specifications	35

Precautions

1. Do not disassemble, open, or repair this speedlight by yourself.
2. Always use batteries of the same type, brand, and age. Always replace all 4 batteries at the same time. Do not combine different types, brands, old, or new batteries. This could cause the batteries to overheat, leak, or explode.
3. This product is not water-resistant. Keep it away from rain, snow, and high humidity areas.
4. Install the batteries in proper orientation as indicated in the battery chamber. Installing the batteries incorrectly could cause them to overheat, leak, or explode.
5. If you change the batteries after a period of sustained continuous firing of the speedlight, the batteries may become warm or hot. This is normal, however you should be careful when handling these batteries.
6. Always switch the speedlight off before changing batteries.
7. Do not fire the speedlight from a short distance directly into the eyes of people or animals. This can cause damage to the retina and may even lead to blindness.
8. Avoid corrosive or flammable substances when cleaning this speedlight.
9. Do not touch the speedlight with wet hands. This could cause an electrical shock.
10. Remove batteries from the unit before storing.

Foreword

Thank you for purchasing the [pro]master 200ST-R.

The ProMaster 200ST-R speedlight is a high performance, feature-rich unit designed to work with your camera's automatic and advanced functions. It can work as your primary on-camera flash or slave unit in a wireless, multiple flash setup (ProMaster ST1C required as master).

Here are some of the 200ST-R's features:

■ E-TTL II Mode

In a Canon flash system, monitor pre-flashes are fired at all times. The subject is correctly exposed and the overall exposure is less affected by challenging ambient light conditions.

■ Manual Mode

By setting the camera's aperture and the speedlight output level, you can manually control exposure. 22 levels of light control are available in manual mode.

■ Repeating Flash Mode (RPT)

The 200ST-R fires repeatedly to create stroboscopic multiple-exposure effects in RPT Mode. This is useful when shooting a fast-moving subject for a creative effect.

■ Flash Exposure Lock

Flash exposure Lock, or "FEL" controls the amount of flash exposure for a subject. Using FELock with a compatible camera you can lock in the appropriate flash exposure for the main subject. This flash exposure is locked in, even if you change the aperture or composition, or zoom the lens in and out.

■ HSS High-Speed Sync

High-Speed flash synchronization at the compatible camera's highest shutter speed is possible. This is useful when you want to use a wider aperture to achieve shallow depth of field to blur the background or create a "stop-motion" effect in your photograph while shooting in conditions with bright ambient light.

Foreword (continued)

■ 2.4G Wireless Slave

The 200ST-R uses a 2.4GHz wireless slave system. It can receive signals from an ST1 (sold separately). You can use up to 5 groups with a wireless range of 325' / 100 meters .

■ Flash Exposure Compensation.

Flash output level compensation is performed by modifying the flash output level for the flash illuminated subject.

■ Rear-Curtain Sync

Rear-Curtain flash sync. creates a picture in which the blur of a moving subject appears behind the subject and not in front. In this mode, the speedlight fires just before the rear shutter curtain starts to close.

■ Bounce Flash

By tilting or rotating the flash head, you can bounce the light off a ceiling or wall to make use of reflected light to create a large, soft illumination.

■ Key Lock

The speedlights's control buttons can be locked to prevent them from being pressed accidentally.

■ AF-Assist Illuminator

The 200ST-R emits an AF-Assist beam to help the camera properly auto focus in low light situations.

■ LCD Panel Backlight

This function sets the LCD panel backlight to on or off.

- Read this instruction manual while also referring to your camera's instruction manual.
- The 200ST-R's features rely on having a compatible camera.

Protection Film

200ST-R has a protection film over the LCD screen and red lens (front cover). It can protect the LCD screen and front cover from scratches and damage. You may move the protection film or leave it in place if you wish.

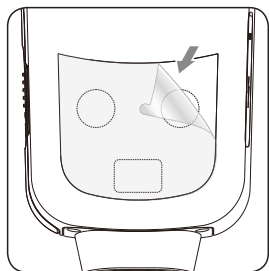

Parts Identification

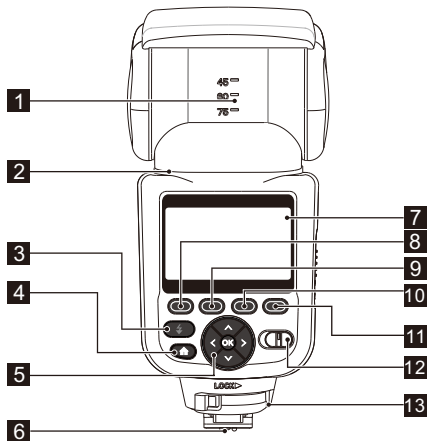

- | | |
|--|--------------------------------|
| 1 Tilting angle scale | 7 LCD panel |
| 2 Rotating angle scale | 8 Function button 1 |
| 3 Test firing button/Ready light | 9 Function button 2 |
| 4 Home button | 10 Function button 3 |
| 5 Up/Down/Left/
Right/OK buttons | 11 Function button 4 |
| 6 Hot foot/
Communication contacts | 12 Power switch(OFF/ON) |
| | 13 Locking lever |

Parts Identification

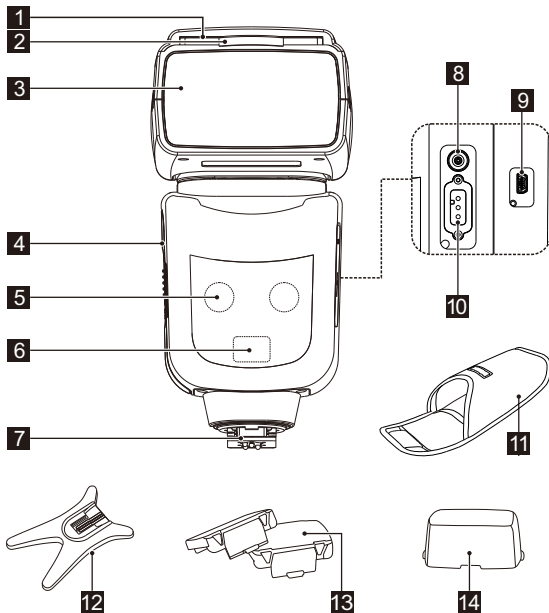

- 1** Bounce card
- 2** Built-in wide panel
- 3** Flash head
- 4** Battery door
- 5** AF-assist beam emitter (Ready-light)
- 6** Optical slave
- 7** Locking pin















- 8** PC sync. terminal
- 9** USB firmware upgrade port (Mini-B 5-pin)
- 10** External power source socket (H.V. port)
- 11** Protective storage case
- 12** Speedlight stand
- 13** Color filters
- 14** Speedlight diffuser

LCD Screen Icons

Shown below are some of the more common icons you will see on the LCD screen of the 200ST-R while using various modes. Additional icons are shown and explained throughout this manual to help you better understand each mode and its features.

* Note: many of the modes used with these icons are dependent on your camera's capabilities. Refer to its instruction manual.

Icons

	Front-curtain sync	Controls when the 200ST-R will flash relative to the timing of the camera's shutter. In front-curtain sync, the flash fires when the shutter is first opened. In rear-curtain sync the 200ST-R will fire as the shutter closes. This is particularly important when shooting a subject in motion using a long shutter speed to get a blur.
	Rear-curtain sync	Using rear-curtain sync will show the subject sharp (from the flash illumination) at the end of the blur for a more natural look. For most other types of photography front-curtain sync is advisable.
	High speed sync	Allows the flash to synchronize with your camera set to a very fast shutter speed (up to 1/8,000 second). This is useful when using a large lens aperture to achieve shallow depth of field in bright ambient light conditions where flash illumination is also used.
	Exposure bracketing	Works with your camera to take a series of pictures at different flash exposures from dark to light.
	Radio(2.4G) wireless state	Indicates communication with a compatible ProMaster ST1 transceiver in a wireless flash environment.
	Slave icon	This icon simply means the 200ST-R is set to some type of slave mode. This includes 2.4GHz wireless slave mode and the F1 / F2 optical slave modes.
	Standby	Means the speedlight has entered sleep mode to conserve power.
	AF-assist beam emitter on	Allows the 200ST-R's red-patterned beam to aid your camera in focusing in dark situations.
	Exposure compensation	Is the amount of light the 200ST-R will emit above or below the average exposure setting.
	Audible alert	Is an icon that will appear so you know the 200ST-R's audible alert system is turned on and is active.
	Batteries low power	Alerts you it is time to replace the batteries.
	Flash firing OFF	Prevents the 200ST-R from firing even though the unit is turned on.
	Front-Curtain/ Rear-Curtain/ High-speed sync switching	Indicates the proper function button to press and enter Sync Mode, where you can choose among front-curtain, rear-curtain, and high-speed sync.
	High temperature icon Low → High	Shows the temperature of the flash head from low to high by the increasing scale inside of this icon.

Inserting the Batteries

Use any of the following three types of AA battery.

- Alkaline batteries
- Ni-MH batteries
- Lithium-metal batteries

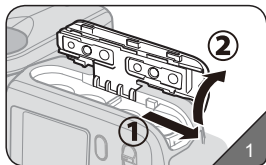

1 Open the cover.

Slide the cover in the direction of the arrow and flip it open.

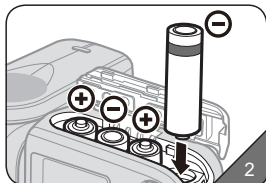

2 Install the batteries.

Make sure the + and - battery contacts are properly oriented as shown inside the battery compartment.

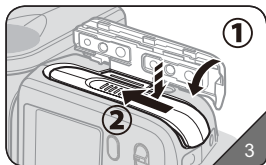

3 Close the cover.

Close the battery compartment cover by flipping it down, pressing, and sliding it closed.

- Do not use the Lithium iron phosphate batteries and Carbon zinc batteries.
- If you change the batteries after firing many continuous flashes, be aware that the batteries might be hot.
- Before changing the batteries, be sure to turn off the speedlight.
- When you change the batteries, be sure to use the same type and with full power.
- Remove batteries from the speedlight before storing.

Attaching and Detaching

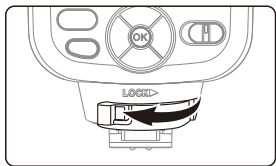

1 Prepare to attach the Speedlight.

Slide the locking lever to the left. If the lever is in the locked position (to the right) push its button to release it before sliding left.

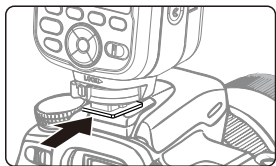

2 Attaching the Speedlight.

Mount the Speedlight into the camera's hot shoe all the way.

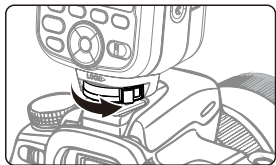

3 Securing the Speedlight.

On the mounting foot, slide the locking lever to the right until it locks in place.

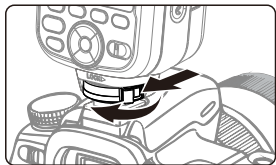

4 Detaching the Speedlight.

While pressing the lock-release button, slide the locking lever to the left and detach the speedlight by sliding it out of the camera's shoe.

- Before attaching or detaching the speedlight, be sure to turn off the speedlight.

Turning On the Power



- Slide the power switch to [ON].



- The test firing button / ready light [⚡] will glow red while the 200ST-R is charging. It will turn green when the speedlight is ready to flash.

★ Please note the test firing button requires more pressure to operate than the other buttons on the 200ST-R. This is intentionally designed to prevent accidental firing.

- If the test firing button remains red over 20 seconds, or the low power icon is displayed, please replace the batteries with new ones.
- The 200ST-R will enter sleep/standby mode after 90 seconds of non-use. You can press the test firing button to wake it up. This feature can be disabled in the Utility menu.

Home Screen and Key Lock

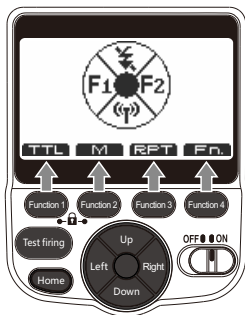

The home screen can be reached by pressing the home button. From here you can change the 200ST-R's mode. Notice the icons on the home screen visually identify which button you should press to access each mode. From the home screen you can quickly access TTL, Manual, Repeat, Custom Functions (Utility menu), Flash OFF, or any of 3 types of wireless slave modes with the press of a button.

Key Lock



Using the 200ST-R's Key Lock function allows you to prevent accidental changes to the settings. It locks all buttons from functioning except the test firing button.

Press function buttons 1 and 2, between which a lock icon is printed, simultaneously for 2 seconds. The key lock icon [LOCKED] will appear on the LCD and the buttons are locked.

To cancel key lock, press function buttons 1 and 2 again, simultaneously for 2 seconds.

★ The test button is not limited by lock function.



Setting Custom and Personal functions

You can customize the speedlight's features to suit your shooting preferences with Custom Functions and Personal Functions. Personal Functions are customizable functions unique to the 200ST-R.

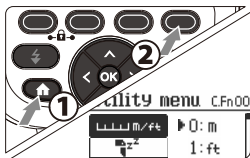
■ C.Fn: Custom functions(C.Fn)





1 Display the Custom Functions screen (Utility menu).

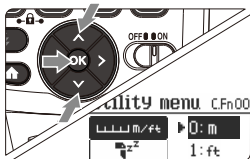



- Press the home button [].
 - Press function 4 [].
- * The Utility Menu screen is displayed.



2 Select a Custom Function.

- Press the arrow buttons [] / [] to select a custom function to set.

3 Change the setting.

- Press the [] button.
- * The custom function setting is displayed.
- Press the arrow buttons [] / [] to change the setting, and then press the [] button to confirm the change.
 - Press the home button [] to exit the Utility Menu.

■ P.Fn: Personal functions(P.Fn)

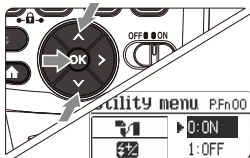

1 Display the Personal Functions screen.

- Enter the Utility Menu the same way you did in step 1 above. Next use the down arrow button to move through all the custom functions until the personal functions appear.

2 Set the function.

- Set the Personal Function in the same way as steps 2 and 3 for the Custom Functions above.

Utility Menu

Custom Functions

NO.	Functional description	
C.Fn 00	m/ft	Distance indicator display
	0: m	Meters
	1: ft	Feet

NO.	Functional description	
C.Fn 01	z	Auto power off (90 seconds)
	0: ON	ON/ Enabled
	1: OFF	OFF/ Disabled

NO.	Functional description	
C.Fn 02	MODELING	Modeling light
	0: 	Enabled/Depth-of-field preview button
	1: 	Enabled/ Test firing button
	2: 	Enabled/ With both buttons
	3: OFF	OFF/ Disabled

NO.	Functional description	
C.Fn 03	AUTO CANCEL	FEB auto cancel
	0: ON	ON/ Enabled
	1: OFF	OFF/ Disabled

NO.	Functional description	
C.Fn 04		FEB sequence
	0: 0→++	Standard→Decreased→Increased
	1: →0++	Decreased→Standard→Increased

NO.	Functional description	
C.Fn 05	MODE	Flash metering mode
	0: ETTL-II	E-TTL II
	1: TTL	TTL

NO.	Functional description	
C.Fn 06	QUICK	Quick flash with continuous shot
	0: OFF	ON/ Enabled
	1: ON	OFF/ Disabled

NO.	Functional description	
C.Fn 07	TEST	Test firing in TTL mode
	0: 1/32	1/32 output
	1: 1/1	1/1 full output

NO.	Functional description	
C.Fn 08	AF	AF-assist beam
	0: ON	ON/ Enabled
	1: OFF	OFF/ Disabled

NO.	Functional description	
C.Fn 09		Auto zoom for sensor size
	0: ON	ON/ Enabled
	1: OFF	OFF/ Disabled

NO.	Functional description	
C.Fn 10	z	F1/F2 Slave auto standby
	0: 60min	60 minutes
	1: 10min	10 minutes

The 200ST-R will enter standby mode after 60 minutes or 10 minutes of non-use, depending on your setting for C.Fn10. If it is in F1 or F2 slave mode, you will need to press the slave's test button to wake it up. If it is in 2.4GHz slave mode, a test fire from the master ST1 will wake it up.

NO.	Functional description	
C.Fn 11	z	Slave auto power off cancel
	0: 8h	Within 8 hours
	1: 1h	Within 1 hour

NO.	Functional description	
C.Fn 12		Flash recycle with external power(H.V. port)
	0: 	External & internal power
	1: 	External power only

NO.	Functional description	
C.Fn 13		Flash exposure compensation setting
	0: 	Function 2 and left/right button
	1: 	Left/right button only

* C.Fn 13 applies to TTL and M modes. When set to [0] you must press the +/- Fn button before making an exposure compensation change with the left / right arrow buttons. If set to [1] you can simply press the left or right arrow to change the exposure compensation without pressing the +/- Fn button first.

Utility Menu

Custom menu setting

▲ → Fn. → ▲/▼ button → OK button → ▲/▼ button → OK button

- C.fn 06 allows the 200ST-R to flash even if it has not fully recycled. This means it can work faster from shot to shot but may not fire at the correct exposure.

Personal Functions

NO.	Functional description	
P.Fn00		Sound monitor(beeep)
	▶ 0:ON	ON/ Enabled
	1:OFF	OFF/ Disabled
Sounds monitor beeps when: Power on / Press buttons / Low power High temperature / Firing		

NO.	Functional description	
P.Fn01		Display backlight
	0:ON	ON/ Enabled
	1:OFF	OFF/ Disabled
▶ 2:12S	On for 12 seconds	

NO.	Functional description	
P.Fn02		Slave unit recycle state
	▶ 0:	AF flashes &
	1:	Ready light only
With the 200ST-R in slave mode and this function set to [0] the AF light will flash to alert you when the unit is ready to fire. When set to [1] this function is cancelled, and only the ready light will alert you by glowing green.		

NO.	Functional description	
P.Fn03	RESET	Reset all Custom & Personal function settings
	▶ 0:NO	Not reset
	1: YES	Reset
Press [1] and then the [OK] button and all custom and personal functions will be cleared and returned to factory settings.		

NO.	Functional description	
P.Fn04		Temperature monitor
	▶ 0:ON	ON/ Enabled
	1:OFF	OFF/ Disabled
⚠ If you turn off the Temperature monitor, flash recycle time will be extended to prevent overheating and you may shorten the life of the flash tube.		

NO.	Functional description	
P.Fn05		Key(buttons) backlight
	0:ON	ON/ Enabled
	1:OFF	OFF/ Disabled
▶ 2:12S	On for 12 seconds	

NO.	Functional description	
P.Fn06	CONTRAST	LCD Display screen contrast
	HIGH	High level
	▶ MID	Middle level
LOW	Low level	

NO.	Functional description	
P.Fn07	VER	Version of firmware
	v x.x	Version
P.Fn07 simply displays the current version of firmware your 200ST-R is using. You cannot change it from this function. You can only view it here.		



When 200ST-R flashes in rapid sequence many times, the Temperature Monitor may be activated.

- ① Temperature monitor enabled: When the icon displays and flashes, the speedlight won't flash.
- ② Temperature monitor disabled: When the icon displays and flashes, the speedlight can fire, but the recycle time will be extended.

TTL: E-TTL II Mode

In this mode information obtained by monitor pre-flashes and exposure control information is integrated by the camera to automatically adjust flash output levels for proper exposure.

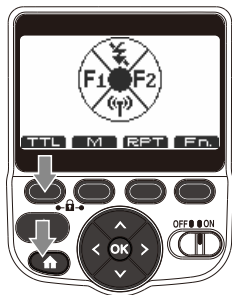

1 Enter TTL mode

Press the home button []

Press the [Function 1] button to set to [TTL]

2 Adjust the exposure compensation amount

Press the Function 2 button []

Use the arrow buttons [<] / [>] for adjustment

Press the Function 2 button [] to confirm your selection

* You also can also use the [OK] button or half press the camera's shutter button to confirm your selection

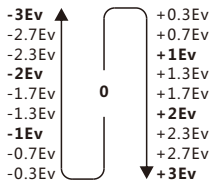

EV compensation scale shown for your reference

- If you prefer to adjust exposure compensation by simply pressing the left/right arrows and without having to press the Function 2 button first, you can set this as a custom function for the 200ST-R in its Utility menu. It is C.Fn13.

M: Manual Mode

In manual mode you can set the flash output from 1/128 power to 1/1 full output in 1/3 steps increments. The 200ST-R will flash at your manually set power level without any TTL, automatic exposure control.

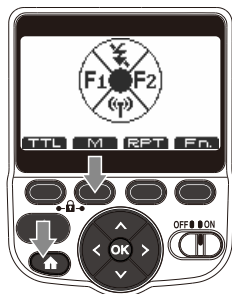

1 Enter M mode

Press the home button []

Press the [Function 2] button to set to []

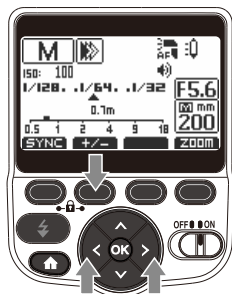

2 Set the flash output

Press the Function 2 button []

Use the arrow buttons [<] / [>] for adjustment

Press the Function 2 button [] to confirm your selection

* You can also use the [OK] button or half press the camera's shutter button to confirm your selection

Minimum power flash

← 1/128 • • 1/64 • •

1/32 • • 1/16 • • 1/8

1/1 • • 1/2 • • 1/4 • •

Full power flash ←

Manual adjustment scale shown for your reference.
22 levels of light output control are possible.

Repeating Flash Mode

In RPT mode, the 200ST-R fires repeatedly during a single exposure, creating stroboscopic multiple-exposure effects. This is useful when shooting fast-moving subjects.

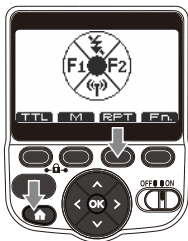

1 Enter RPT mode

Press the home button []

Press the [Function 3] button to set to []

2 Set the flash output

Press the Function 1 button []

Use the arrow buttons [< / >] for adjustment

Press the Function 1 button [] to confirm your selection

3 Set the number of flashes (times)

Press the Function 2 button []

Use the arrow buttons [< / >] for adjustment

Press the Function 2 button [] to confirm your selection

4 Set the flash firing frequency

Press the Function 3 button []

Use the arrow buttons [< / >] for adjustment

Press the Function 3 button [] to confirm your selection

* You can also use the [OK] button or half press the camera's shutter button to confirm your selection.

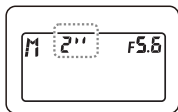
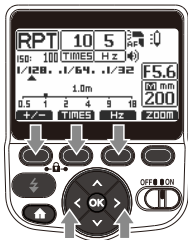

5 Set the camera's shutter speed

- Shutter speed = Number of flashes + flash frequency
For example, if the number of flashes is set to 10 (times) and the flash frequency to 5(Hz), set the shutter speed to 2 sec. or longer.
- "Bulb" mode can also be used for the shutter speed.

- The maximum flash firing number is a function of flash output level and flash firing frequency. See the table in the Appendix for more details. The 200ST-R will not allow you to set an unachievable combination of these settings.
- To avoid overheating and damaging the flash head, do not use RPT flash more than 10 times in succession. After shooting 10 times, allow a rest time of 5-10 minutes to prolong the life of the flash tube.

Slave Mode F1 (Optical)

The F1 slave mode is used in a manual flash environment. The 200ST-R is triggered optically by another flash (non-radio) by the first burst of light it sees. It will not ignore a pre-flash if one exists from the master.

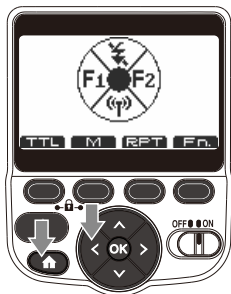

1 Enter F1 slave mode

Press the home button [**⏠**]



Press the left arrow button [**<**] to select [**F1**] mode

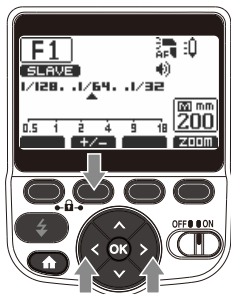

2 Set the flash output

Press the Function 2 button [**+/-**]



Use the arrow buttons [**<**] / [**>**] for adjustment



Press the Function 2 button [**+/-**] to confirm your selection

* You can also use the [**OK**] button to confirm your selection

- When the 200ST-R is in F1 slave mode, it will fire in-sync. with the master flash. To use this mode correctly, the master speedlight should be set as a manual flash and its TTL flash mode with pre-flash and red-eye reduction modes should not be used so as to avoid firing the 200ST-R slave out of sync. The master should be aimed at the front of the 200ST-R so its optical slave can see the master's flash.

Slave Mode F2 (Optical)

The F2 slave mode is normally used when the master flash is in TTL mode. F2 slave works as an optical slave and ignores the first burst of light it sees, thereby ignoring the master's pre-flash monitor and firing in-sync. with the master's true flash.

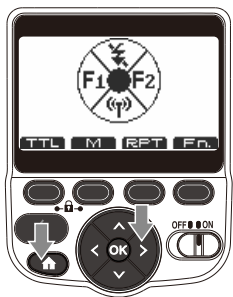

1 Enter F2 slave mode



Press the home button []

Press the right arrow button [] to select [**F2**] mode



2 Set the flash output

Press the Function 2 button []

Use the arrow buttons [] / [] for adjustment

Press the Function 2 button [] to confirm your selection

* You can also use the [**OK**] button to confirm your selection

- When the speedlight is in F2 mode it can support the master speedlight in TTL mode.
- As a basic guide, the effective shooting distance between the master and slave units in F1 or F2 is approx. 10M (33 ft.). The range will vary slightly depending on the ambient light. Don't place any obstacles between the master and slave units (F1/F2).

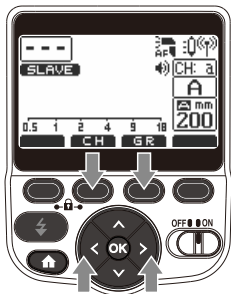
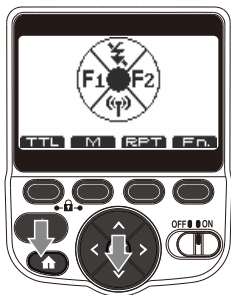

2.4 GHz Slave Mode (Radio)

When set as a radio slave unit, the 200ST-R can receive signals from a ProMaster ST1C transceiver (sold separately) in master mode. The ST1C can control up to 5 groups using one of 15 channels or auto channel for its slave units, reliably, over a long distance (325' / 100 m), with optional TTL exposure and other advanced features.



1 Enter 2.4 GHz slave mode

Press the home button []

Press the arrow button [] to set to []

2 Set the channel (CH)

Press the Function 2 button []

Use the arrow buttons [<] / [>] for adjustment

Press the Function 2 button [] button to confirm your selection

* You can also use the [OK] button to confirm your selection. Channel Range: a (auto) + 1-15

3 Set the group (GR)

Press the Function 3 button []

Use the arrow buttons [<] / [>] for adjustment

Press the Function 3 button [] to confirm your selection

* You can also use the [OK] button to confirm your selection. Group Range: A, B, C, D, E

- If another photographer is using the same type and same channel of transmitter nearby, your speedlight may accidentally fire in-sync. with that photographer's transmitter. Please change to a different channel number.
- Be sure the 200ST-R is set to the same channel as the ST1C master.

FEB

You can take three shots while automatically changing the flash output. This is called FEB (Flash Exposure Bracketing). The settable range is up to ± 3 stops in 1/3-stop increments.

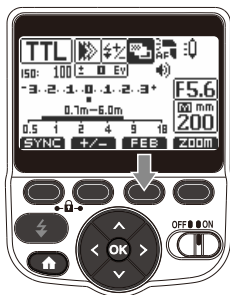

1 Press the [FEB] button

- Press the Function 3 button [FEB].
- * [] is displayed and the FEB level display is highlighted.

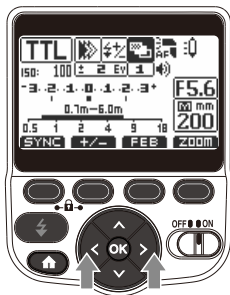

2 Set the FEB level.

- Use the arrow buttons [<]/[>] to set the FEB level.
- “0.3” indicates 1/3 stops and “0.7” indicates 2/3 stops.
- When used together with flash exposure compensation, FEB shooting is performed based on the flash exposure compensation amount. When the FEB range exceeds ± 3 stops, the end of the flash exposure level shows.

- After the three shots are taken, FEB is canceled automatically.
- Before shooting with FEB, it is recommend to set the camera's drive mode to single shooting and check that the flash is recycled.
- You can use FEB together with flash exposure compensation or FE lock.
- You can set FEB to remain enabled after shooting the three shots(C.Fn-03).
- You can change the FEB shooting sequence(C.FN-04).

FEL: FE Lock

FE (Flash Exposure) lock locks the correct flash exposure setting for any part of the scene.

While [TTL] is displayed on the LCD panel, press the camera's [M-Fn] button. On cameras without a [M-Fn] button, press the [FEL] or [*] (AE lock) button.

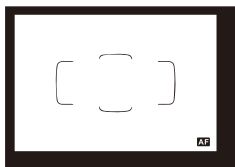

1 Focus the subject.

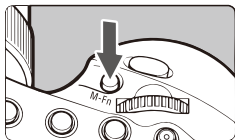

2 Press the <M-Fn> button.

- Aim the center of the viewfinder at the subject and press the <M-Fn> button.
 - * The Speedlight fires a preflash, and the flash output required for the subject is retained in the memory.
 - * "FEL" will be displayed in the viewfinder for 0.5 sec.
- Each time you press the <M-Fn> button, a preflash will be fired and the new flash output required at that time is retained in the memory.

- If a correct exposure cannot be obtained when FE lock is performed, [1/4] blinks in the viewfinder. Move closer to the subject, open the aperture, and perform FE lock again. You can also increase the ISO speed and perform FE lock again when using a digital camera.
- If the target subject is too small in the viewfinder, FE lock might not work effectively.

High-speed Sync

With high-speed sync, the flash can synchronize with all shutter speeds. This is convenient when you want to use aperture-priority AE for fill-flash portraits of a subject.

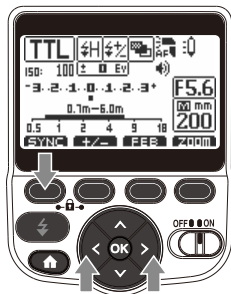



Enter [H] mode

Press the Function 1 button []

↓
Press the [<] / [>] button to display [ H]

↓
Check that [ H] is lit in the viewfinder

- With high-speed sync, the faster the shutter speed, the shorter the effective flash range(distance) will be. Check the effective flash range on the LCD panel.
- If you set a shutter speed that is equal to or slower than the camera's maximum 'normal' flash sync speed, [ H] will not be displayed in the viewfinder.
- To return to normal flash shooting, press function button 1 [] to turn off [ H].
- High-speed sync is not available during stroboscopic (RPT) flash.

Second-curtain Sync

Shooting with a slow shutter speed and second-curtain sync captures the blur of moving objects, such as a moving car, in a natural way. The flash fires right before the exposure finishes (shutter closes) and the blur appears behind the object's direction of motion.



Enter [] mode

Press the Function 1 button []

Press the [] / [] button to display []



First(front)-curtain sync



Second(rear)-curtain sync

- Second-curtain sync works well when the camera's shooting mode is set to "BULB".
- To return to normal flash shooting, press function button 1 [] to turn off [] .
- When the flash mode is set to [TTL], the flash fires twice. This first flash is a preflash to determine the flash output. It is not a malfunction.
- Second-curtain sync is not available during wireless flash shooting.

Power Zoom Function

The power zoom function automatically adjusts the flash zoom head position to match the lens focal length. Zoom positions can be adjusted between 24mm and 200mm. You can also adjust the flash zoom head position manually.

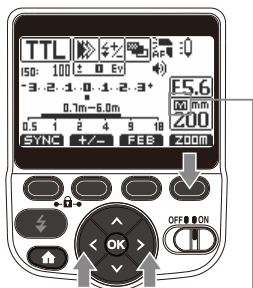

A = Automatic

(The flash zooms in sync with camera lens)

M = Manual zoom

The 200ST-R's zoom range scale

24--28--35--50--70--80--
105--135--200mm

Set Auto zoom

Press the Function 4 button [**zoom**]

Press the left arrow [**<**] button until **A** is displayed

Press the Function 4 button [**zoom**] to confirm the **A** setting. Zoom your lens and watch the power zoom match its focal length setting.

* You can also use the [**OK**] button or half press the camera's shutter button to confirm your selection.

Set Manual zoom

Press the Function 4 button [**zoom**]

Press the right arrow button [**>**] to take the 200ST-R out of **A** mode and into **M** mode. Keep pressing the right arrow button to manually adjust the power zoom up the scale and use the left arrow button to adjust down the scale. Notice the equivalent focal length is shown in mm. If you press the left arrow button beyond 24mm the zoom will return to **A** mode.

Press the Function 4 [**zoom**] button to confirm the **M** zoom setting.

* You can also use the [**OK**] button or half press the camera's shutter button to confirm your selection.

- If you use a PC. sync. cord to connect your camera to the speedlight's PC terminal, set the flash zoom manually.
- If you use the wide panel, the flash zoom will lock in at 18mm.

AF Assist Beam Emitter

In low light conditions the AF assist light will automatically emit a red beam pattern towards the subject so the camera can auto-focus.

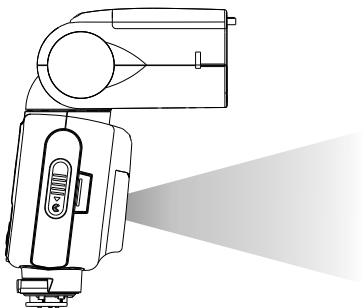

■ Turning the AF Assist Beam Off or On

Press the home button []



Press the Fn 4 button to enter the Utility Menu



Use the up/down arrow buttons []/[] to display C.Fn08



Press the [**OK**] button to enter C.Fn08



Press the up/down arrow buttons []/[] to highlight <ON> or <OFF>



Press the [**OK**] button to confirm your selection

Bounce Flash Operation

Tilt or rotate the 200ST-R's flash head to bounce the light off a ceiling or walls, providing more natural-looking pictures of people with softer shadows.

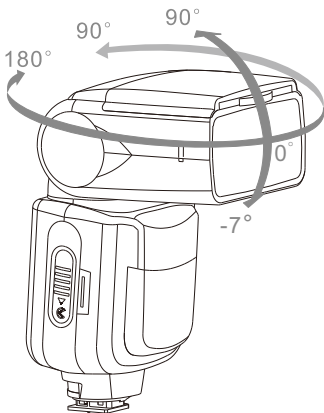

Vertical angle adjustment: -7° -- 0° -- 45° -- 60° -- 75° -- 90°

Rotation adjustment: Left: 0° -- 30° -- 60° -- 90°)
Right: 0° -- 30° -- 60° -- 90° -- 120° -- 135° -- 180°

- If the wall or ceiling is too far away, the bounced flash might be too weak and can result in under exposure.
- Be sure to select a white/neutral surface to bounce the light off of. Otherwise your pictures will have an unnatural looking color cast similar to that of the reflecting surface.

Using the Bounce Card

You can use the 200ST-R's built-in bounce card to create a highlight in the subject's eyes, soften the light output, and reduce the chance of red-eye (by creating more distance between the light and the lens).

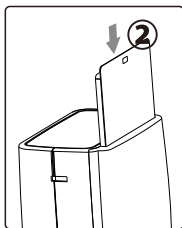
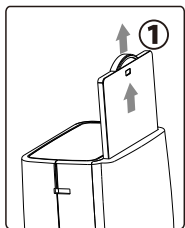

- 1** Pull the round tab. The bounce panel will slide out at the same time as the wide panel.
- 2** Push in only the wide panel leaving the bounce panel exposed.

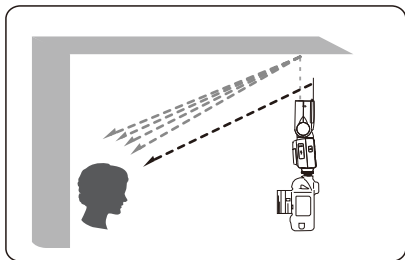

- Direct the flash head forward and straight up by 90°. The bounce card will not work properly if you swing the flash head left or right.
- For maximum effect, stay within 1.5m (4.9ft) of your subject.

- Before pushing in bounce panel, you should slide out the wide panel and push both in together. This is easier and will protect the bounce panel from damage.

Using the Wide Panel

When the distance between the camera and subject is less than approx. 6 1/2' / 2m, you can take more natural-looking close-up pictures using the wide panel. The zoom position will automatically set itself to 18mm when the built-in wide panel is used.

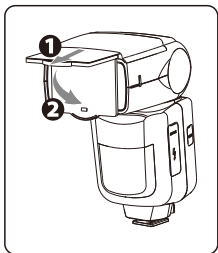

① Pull out the wide panel.

Slowly pull out the wide panel all the way, and position it over the flash head.

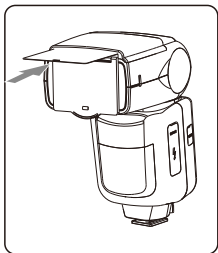

② Push the bounce card back in.

Push in only the bounce card. Leave the wide panel out.

- The wide panel softens and widens the 200ST-R's light beam to approximately 18mm while reducing the maximum distance the light can travel. Do not use this feature when your subject is far away or the flash may become too weak for proper exposure.

Diffusion Dome

- By attaching the included ProMaster Diffusion Dome over the flash head, light can be further diffused during bounce flash photography to create extremely soft light with virtually no shadows.
- The same effect can be achieved with the camera in either a horizontal or vertical position so long as the speedlight is oriented properly.
- Light is more effectively diffused when the built-in wide panel is used in addition to the diffusion dome.

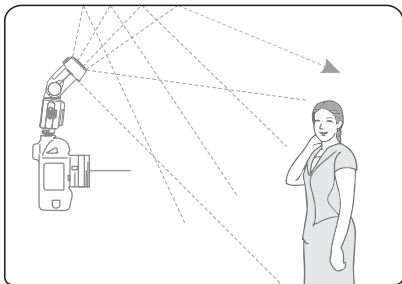

Attaching the ProMaster Diffusion Dome

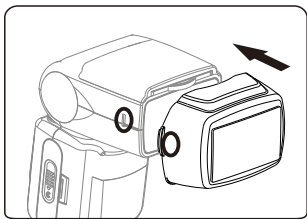

Attach the ProMaster Diffusion Dome as shown in the diagram.

Color Filters

Color compensation filters (fluorescent filter and an incandescent filter) are included with the 200ST-R for use with flash photography under incandescent/tungsten and fluorescent lighting.

■ Using color compensation filters and color filters

Filters	Purpose
Fluorescent filter(Green) included	Balance the color of light from the flash to match that of fluorescent lighting
Fluorescent filter(Orange) included	Balance the color of light from the flash to match that of incandescent or tungsten lighting

■ How to attach color compensation filters (included)

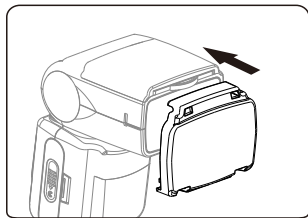

Place the filter on the flash head and insert into the slit at the top.

Place the filter as the shown in the diagram.

Additional Interfaces

The 200ST-R has external connections for use of an external power source (High Voltage battery pack) and PC sync. It also has a USB port for use when upgrading the unit's firmware. This port is compatible with a USB mini-B 5-pin connection.

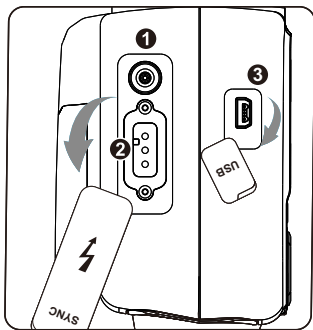

1 Accessing the external power connector and PC sync.

Pull open the rubber cover on the side of the 200ST-R and rotate it out of the way.

2 Usage.

1. PC Sync. terminal: The speedlight can fire in-sync. with a camera using this socket and a compatible PC sync. cord.
2. External power connector: The H.V. (high voltage) port provides a stable power supply using an external battery and compatible power cable. You can choose to draw power from only the H.V. port or from the H.V. port + AA batteries with C.Fn12 in the Utility menu.

3 USB upgrade port

The 200ST-R has a USB upgrade port. You can update the firmware with a newer version, when available. Refer to www.promaster.com

Appendix

Maximum number of flash firings in RPT mode

Frequency	Flash Output					
	M1/4	M1/8	M1/16	M1/32	M1/64	M1/128
1Hz	7	14	30	60	90	100
2Hz	6	14	30	60	90	100
3Hz	5	12	30	60	90	100
4Hz	4	10	20	50	80	100
5Hz	4	8	20	50	80	100
6-7Hz	3	6	20	40	70	90
8-9Hz	3	5	10	30	60	80
10Hz	2	4	8	20	50	70
11Hz	2	4	8	20	40	70
12-14Hz	2	4	8	20	40	60
15-19Hz	2	4	8	18	35	50
20-50Hz	2	4	8	16	30	40
60-199Hz	2	4	8	12	20	40

When the number of the flashes is displayed as "---" (bar display) in the LCD, the maximum number of flashes is as shown in this table.

Guide No.: (ISO 100, in meters)

Flash Output	Flash Coverage (mm)								
	24	28	35	50	70	85	105	135	200
1/1	26.6	30.5	33.5	37.7	43.0	47.2	50.0	56.3	60.0
1/2	18.8	21.6	23.7	26.7	30.4	33.4	35.4	39.8	42.0
1/4	13.3	15.3	16.8	18.9	21.5	23.6	25.0	28.2	30.0
1/8	9.4	10.8	11.9	13.4	15.2	16.7	17.7	19.9	21.0
1/16	6.7	7.7	8.4	9.5	10.8	11.7	12.5	14.1	15.0
1/32	4.7	5.4	6.0	6.7	7.6	8.4	8.9	10.0	10.5
1/64	3.4	3.9	4.2	4.8	5.4	5.9	6.3	7.1	7.5
1/128	2.4	2.7	3.0	3.4	3.8	4.2	4.5	5.0	5.2

Specifications

Type	On-camera, E-TTL II speedlight
Guide No.	Approximately 60m/200' (at 200mm zoom / ISO100)
Flash coverage	24 to 200mm (18mm when using wide panel) ● Manual zoom ● Automatic
Bounce angle	90° Up, 7° Down, 90° Left, 180° Right
Flash modes	TTL/M/RPT
Optic slave modes	F1 / F2
Radio wireless slave mode	<ul style="list-style-type: none">● System type: Digital FSK 2.4GHz wireless● Distance: 100 m / 325'.● Channels: Auto + CH 1-15● Groups: 5 groups (A/B/C/D/E), up to 15 units in a group.
Display type	LCD display
Button backlight	White
Color temperature	5600K
Modeling flash	Fires with camera or speedlight button
Flash exposure compensation	3.0 EV to +3.0 EV in increments of 1/3 EV steps
Manual flash	1/128 to 1/1 power (1/3 steps increments)
AF assist beam emitter	Raster pattern
Recycle time	Normal Flash mode : Approx. 0.15~3 seconds with Ni-MH cells Quick Flash mode (C.Fn06): Approx. 0.1~2 seconds with Ni-MH cells
Firmware update	via USB mini-B 5-pin connection
Custom functions	Supports Custom menu in-camera and via speedlight Utility menu
Standby function	Supports on-camera mode (auto standby after 90 sec. nonuse)
Repeating Flash	1-199Hz
Flash duration range	1/800~1/20,000 sec.
Camera's sync modes	Front-curtain sync, Rear-curtain sync, and HSS high-speed sync up to 1/8,000 second
FE lock	Support
External power	Support via H.V. port
PC terminal	Support
Dimensions	Approx. 7 3/4" x 3 1/16" x 2 5/16" / 196.8 mm x 77.8 mm x 58.7 mm
Weight	Approx. 15 oz / 425 g (speedlight only)